



Image may differ from product. See technical specification for details.

MB 12

미터 단위 잠금 너트용 잠금 와셔

MB and MBL lock washers are locking devices, used to secure KM, KML and HM .. T lock nuts onto a shaft or adapter sleeve and prevent unintentional loosening. MB .. A is a stronger version of the MB washer. The lock washers engage a keyway in the shaft or adapter sleeve thread. They lock the nut in position when one of the washer tabs is bent into one of the slots in the outside diameter of the lock nut. A new lock washer should be used each time the corresponding lock nut is installed.

- Simple, stable and reliable fastening element
- Easy to install and remove
- Used for KM, KML, and HM .. T lock nuts

개요

치수

보어 직경	60 mm
외경	86 mm

속성

고정 장치	락 와셔
-------	------

물류

제품 순 중량	0.02 kg
eClass 코드	23-11-07-05
UNSPSC 코드	31163218

기술 사양

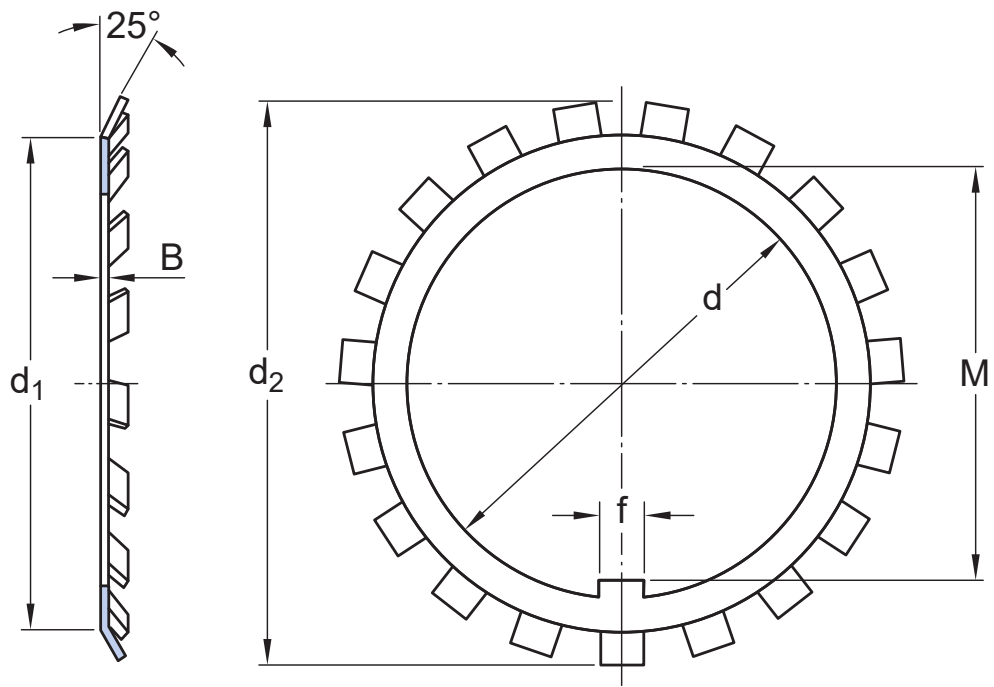

치수

d	60 mm	보어 직경
d_1	73 mm	측면 직경
d_2	86 mm	외경
B	1.5 mm	재료 두께
f	8 mm	내부 탭 너비
M	57.5 mm	내부 탭의 내부 치수

이용약관